

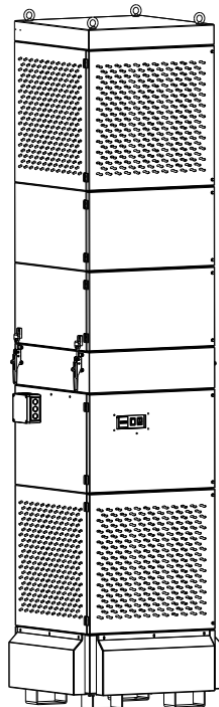

# Operating instructions

(Translation of the original operating instructions)

## ViroLine Tower



## Table of contents

<b>1. General</b>	<b>3</b>
<b>2. Description of the system elements</b>	<b>4</b>
2.1. Illustration of the system elements	4
2.2. Functionality of the system	5
2.3. Intended use	5
2.4. Residual risk	5
<b>3. Safety instructions</b>	<b>5</b>
3.1. Definition of the hazard symbols	5
3.2. General safety instructions	6
<b>4. Storage, transport and installation of the device</b>	<b>7</b>
<b>5. Commissioning</b>	<b>8</b>
5.1. Electrical connection	8
<b>6. Operating the system</b>	<b>9</b>
6.1. Explanation of the operating elements	9
<b>7. Maintenance</b>	<b>10</b>
7.1. Reset to maintenance state	11
7.2. Replacing the prefilter mat	11
7.3. Replacing the particle filter	12
7.4. Replacing the UV-C lamp	13
<b>8. Dismantling / Disposal</b>	<b>14</b>
<b>9. Diagnostics and troubleshooting</b>	<b>15</b>
<b>10. List of spare parts</b>	<b>15</b>
<b>11. Technical data</b>	<b>16</b>
<b>12. EC declaration of conformity</b>	<b>17</b>
<b>13. Training protocol</b>	<b>18</b>
<b>14. Maintenance intervals</b>	<b>19</b>
14.1. Usage-related maintenance	19
14.2. General maintenance	19
14.2.1. Visual inspection of the device	20
14.2.2. Functional test of the device	20
14.2.3. Electrical test of the electrical lines and earthing connections	20

## 1. General

Congratulations on purchasing the product from TEKA.

Our engineers ensure that our devices reflect the state of the art through continuous development. Nevertheless, misuse or misconduct can endanger your safety. Please observe the following for a successful use of the device:

	<p>Only authorised and instructed personnel can carry out transport, operation, maintenance and repair of the device. The operator must ensure that the operating personnel take note of these instructions.</p> <p>Please read these instructions before operating the device, and observe the safety precautions to avoid injury!</p> <p>Store this manual in a safe place! These instructions are to be regarded as a component of the product!</p> <p>Adhere to all product notes!</p> <p>Modifications or conversions that the operator carries out at the device without the consent of the manufacturer, can lead to new safety hazards or to the loss of warranty claims.</p> <p>Observe the manufacturer's instructions. Contact the manufacturer in case of any uncertainty: Tel: +49 2541-84841-0 E-mail: info@teka.eu</p>
---	---

## 2. Description of the system elements

### 2.1. Illustration of the system elements

Installation example:

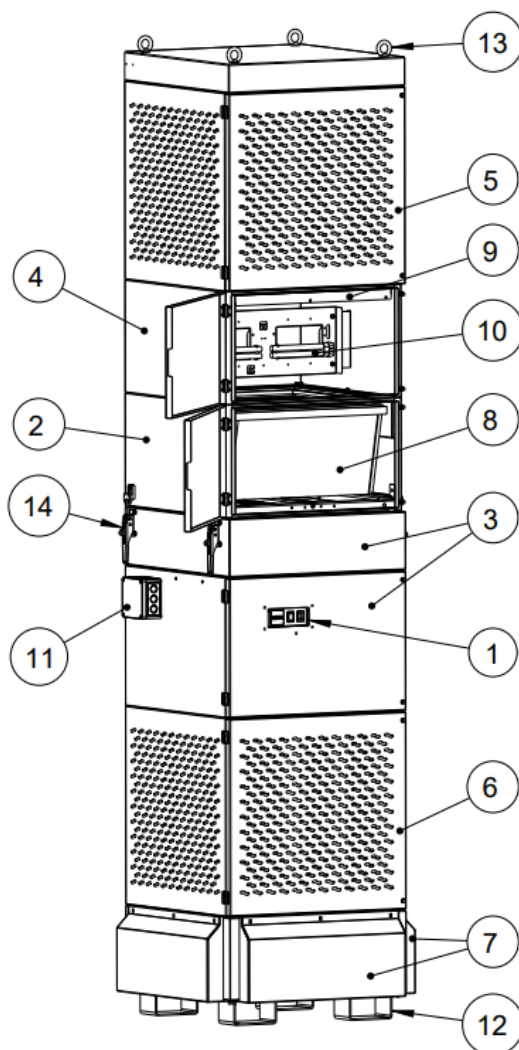

Z.Nr. 20434701

Pos.1	Operating panel of the control	Pos.10	UV-C lamp
Pos.2	Particle filter housing	Pos.11	Mains cable with plug
Pos.3	Fan housing	Pos.12	Forklift skids
Pos.4	Lamp housing	Pos.13	Lifting rings
Pos.5	Suction housing	Pos.14	Toggle lever
Pos.6	Air outlet housing		
Pos.7	Bumper		
Pos.8	Particle filter		
Pos.9	Prefilter mat		

## 2.2. Functionality of the system

At a height of over three metres, the contaminated air is sucked in and is guided through a UV-C irradiation section. Surviving germs that have not been directly killed by the UV-C light are caught by the H14 filter and are then eliminated by continuous exposure to UV-C irradiation. The clean air is fed back into the room via the floor-level air outlets.

## 2.3. Intended use

The device is intended for commercial use. If the device is made publicly accessible, it must never be operated unsupervised by authorized personnel, authorized by the operator.

The filter unit is intended to clean the ambient air from germs, bacteria and viruses.

	<b>WARNING</b>
	<b>Improper use can damage parts and be a danger to life and limb!</b> The device must not be used for the extraction of oil-laden welding fume, explosive dust and gases, hybrid mixtures, glowing or burning substances, gases, water, etc. The device must not be operated in explosive zones.

## 2.4. Residual risk

	<b>CAUTION</b>
	<b>Danger due to possible hazardous materials in the exhaust air flow.</b> Because the unit does not monitor the quality of the air in the exhaust air flow, we recommend that you always guide the exhaust air flow exiting our unit to areas (e.g. to the outside into the open air) in which there is no danger to any living being. To do this, it is necessary to fit a suitable exhaust air line at the filter unit.

## 3. Safety instructions

### 3.1. Definition of the hazard symbols

The device is constructed according to the state of the art and the recognised safety regulations. Nevertheless, during use threats to life and limb of the user or other persons may arise. The impairment of the machine or other property are also possible. In these instructions we warn by using corresponding indications.

	<b>WARNING</b>
	<b>WARNING</b> These instructions are made in case of risks that can lead to <u>injury or death</u> .

	<b>CAUTION</b>
	<b>CAUTION</b> These instructions are made in case of risks that can lead to <u>injury</u> .

	<b>NOTICE</b>
	<b>NOTICE</b> These instructions are made in case of risks that can lead to <u>material damages</u> .

	Information notes are no hazard warnings; they call attention to useful information.
---	--

## 3.2. General safety instructions

	<b>WARNING</b>
	<b>Dangers arising from improper use / unauthorised operations.</b> The operator must ensure that their authorised personnel are familiar with all the safety indications in this manual in advance. The operator is responsible for ensuring that all work is carried out by authorised and qualified personnel. We therefore recommend using the training protocol on the last page for that purpose (see chapter "Training protocol"). Laymen are allowed to operate the device after having received the necessary instructions. But they are not allowed to carry out any installation, repair or maintenance work. The operator must ensure that the device is not operated, opened, serviced or otherwise confiscated by minors (persons younger than 18 years). <hr/> <b>Dangers arising from fire.</b> In case of fire, if possible, switch the unit immediately off or disconnect it from the power supply. Fire extinguishing measures which the operator is obliged to determine beforehand must be initiated immediately.

	<b>WARNING</b>
	<b>Dangers arising from electricity.</b> The operator must ensure that electrical plants and equipment are only built, modified and maintained by a qualified electrician or under the direction and supervision of a qualified electrician. Do not work on components if you are not sure that these are disconnected. If necessary, disconnect the device from the electric power supply and secure it against unauthorized restarting.

## 4. Storage, transport and installation of the device

	<b>WARNING</b>
	<p><b>Risk of injury from tilting or unmounted components when stored or transported.</b> The device must be secured against tilting and slipping when it is stored or transported. Do not stand under or next to the floating load. Lift trucks, forklift trucks and transport cranes must have a sufficient minimum load bearing capacity.</p> <hr/> <p><b>Dangers arising from titling or functional impairments at its destination.</b> The unit may only be set up on a suitable surface. The unit may only be set up on a suitable surface. The surface must be vibration-free and horizontal. The operator must check the bearing capacity of the surface. The unit must be secured on the surface, for example using lag bolts or heavy-duty anchors.</p>

	<b>NOTICE</b>
	<p><b>Damage or functional impairment of the unit due to climatic influences.</b> The unit must be stored in a dry place and protected against moisture during transport. As a matter of principle, the filter unit is not designed to be installed outside.</p>

- The unit is delivered in 2 parts (upper part and lower part). The lower part must first be transported to its destination. Therefore, use the forklift truck skids (see chapter 2.1).

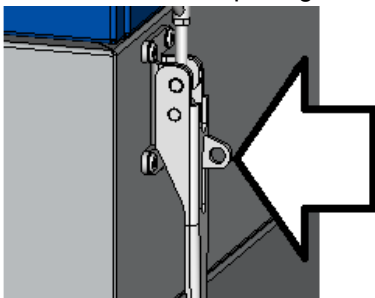

**⚠WARNING** Use appropriate lifting tools (forklift truck, transport crane,...) with a minimum load-carrying capacity of 1000 kg. The unit must be secured against tilting and slipping when it is moved, lifted or put down. No one is allowed to stand under or beside the load.

- Now lift the upper part onto the lower part. Use the lifting rings for this (see chapter 2.1). The doors must be aligned so that the doors of the upper part and these of the lower part are on the same side. As soon as this has been done, the system components must be connected by means of the toggle levers (see chapter 2.1). Finally, secure the toggle levers with screws to prevent accidental opening.



- The unit must then be positioned at its exact destination.  
**⚠WARNING** The assembled complete unit must not be lifted with the lifting rings. Use the forklift truck skids.

## 5. Commissioning

	<b>WARNING</b>
	<p><b>Dangers arising from a defective condition of the unit. There is also a risk to the eyes if there is a direct view of the UV-C lamp.</b></p> <p>Make sure that the measures described in this chapter are completed before the commissioning of the unit. All doors of the unit must be closed and all necessary connections must be attached before turning the unit on. Do not operate the unit if any components are defective, missing or damaged. Check the orderly condition of the unit before switching it on. The unit must not be operated without a filter element.</p>

	<b>NOTICE</b>
	<p><b>Damaged supply lines.</b></p> <p>Make sure that the supply lines are protected against damage by forklift trucks and similar events. Protect all supply lines from heat, moisture, oil and sharp edges.</p>

### 5.1. Electrical connection

	<b>NOTICE</b>
	<p><b>Electric malfunction possible in cause of an incorrect power supply.</b></p> <p>Pay attention to the admissible supply voltage. Please observe the specifications on the type plate.</p>

- Connect the mains cable (see chapter 2.1) to the power supply.
- Insert the cable with the Harting connector into the corresponding jack. This supplies the UV-C lamps with electricity.







## 6. Operating the system

### 6.1. Explanation of the operating elements

Operating elements for the device control		
Representation	Designation	Description / function
	ON-OFF-switch (2x)	<p>The switch switches the fan / UV-C lamps on and off.</p> <p><b>i</b> When the device is switched off, it is <u>not</u> disconnected from the power supply.</p> <p><b>i</b> The fan and the UV-C lamps are switched separately from one another.</p> <p><b>Our recommendation:</b> Switch the fan ON if there are persons in the room for long periods. And only switch the UV-C lamps ON if the fan is switched OFF.</p>

Operating elements for status and error messages		
Representation	Designation	Description / function
	Signal lamp "red"	Flashing up means that the air-flow rate of the device is not sufficient anymore. Filter elements must be cleaned or replaced.
	Operating hour counter	The number of operation hours during which the device was in operation is shown.



## 7. Maintenance

In accordance with national regulations, the operator is obliged to carry out repeat and functional tests. Unless otherwise specified by national regulations, we recommend regular visual inspections and functional tests of the device as described in the chapter “Maintenance intervals”.

 You find the chapter “Maintenance intervals” at the end of the document. The general maintenance (visual inspection, etc.) is also explained there.

In the chapter “Maintenance intervals” there is information on the maintenance intervals of the filter elements. But these are only recommendations. Depending on the application (multi-shift operation, dust generation, ...) it may be necessary for the operator to change the maintenance intervals.

In this chapter the maintenance work which is caused by wear caused during operation is described.

<b>WARNING</b>	
 	<p><b>Work on the open system entails the risk of electrical shock or accidental restart the system. Both pose a danger to life and limb. There is also a risk to the eyes if there is a direct view of the UV-C lamp.</b></p> <p>When cleaning and servicing equipment during the replacement of parts or when changing to another function, set the device to maintenance condition first (see chapter “Reset to maintenance state”).</p> <p>A recommissioning of the device must only occur if it is ensured that the device is functionally equivalent to the original state.</p> <hr/> <p><b>Dangers to life and limb when non-original spare parts are used</b> Only original TEKA spare parts must be used.</p>

<b>CAUTION</b>	
	<p><b>Hazards to the respiratory tracts are possible.</b></p> <p>All maintenance work must only be carried out in well-ventilated rooms and while wearing an appropriate respiratory mask! We recommend: respiratory protection half mask DIN EN 141/143 protection level P3. For all maintenance work ensure a cautious handling of filter elements and components in order to avoid whirling up dust.</p> <hr/> <p><b>Notes regarding SARS-CoV-2 (Coronavirus)</b></p> <p>In relation with SARS-CoV-2, the german RKI (Robert-Koch-Institut) has published a section on its website with information on the disposal of waste:: <a href="https://www.rki.de/DE/Content/InfAZ/N/Neuartiges_Coronavirus/Hygiene.html">https://www.rki.de/DE/Content/InfAZ/N/Neuartiges_Coronavirus/Hygiene.html</a></p> <p>Please note that the information provided there (e.g. on waste disposal) is updated from time to time. So always take into account the current status of waste disposal.</p> <p>We recommend: Stow the changed (filter) elements in tear-resistant and tightly closed plastic bags before disposal, so that contact is avoided in the further disposal process. Disposal can take place via the mixed waste / residual waste.</p>



 The operator is obliged to store and dispose of the collected dust in accordance with national or regional regulations. For all maintenance or cleaning work please refer to the applying environmental regulations. Pollutants and filter elements must be disposed of or stored according to the regulations as well. If you have any doubts, we recommend contacting a disposal contractor in your area.

## 7.1. Reset to maintenance state

- Switch off the unit. Unplug the mains plug. Secure the unit against unauthorized restarting during maintenance.
- After completion of all maintenance work the unit can be reconnected to the power supply.

## 7.2. Replacing the prefilter mat

The prefilter mat is installed upstream to the particle filter and separates the coarse particles.

The prefilter mat must be changed after a certain number of operating hours. The time depends on the amount of accumulated dust, and therefore cannot be determined beforehand. At the latest, the prefilter mat must be changed when changing the particle filter.

	<b>CAUTION</b>
<b>Whirling up dust is possible.</b> The prefilter mat is a disposable filter element. Do not try to clean the filter element.	

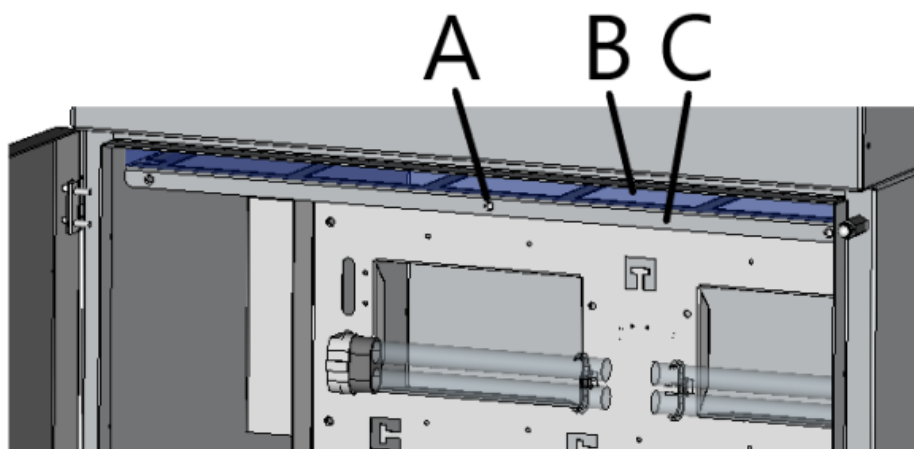

- Open the service door of the lamp housing (see chapter 2.1).
- Loosen the 3 screws (A) and remove the locking plate (A).
- Remove the prefilter mat (B) from the insert frame (C) and dispose of or store it according to the regulations.
- Put a new prefilter mat into the insert frame.  
**NOTICE** Only use TEKA spare filters. Otherwise the proper functioning of the unit is not guaranteed, and there is a danger to life and limb.
- Assemble the locking plate again with the 3 screws.
- Close the service door.

## 7.3. Replacing the particle filter

Replacing the particle filter is necessary when the device control signals the corresponding error. (see chapter "Description of the control elements").



### CAUTION

**Whirling up dust is possible.**

The particle filter is a disposable filter element. Do not try to clean the filter element.



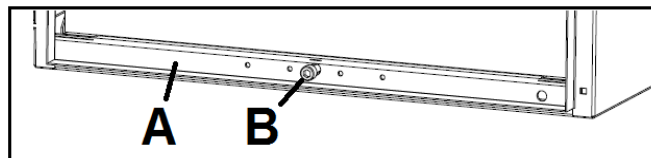

When replacing the particle filter, the prefilter mat must be replaced as well.



- Open the service door of the particle filter housing (see chapter 2.1).
- Lower the lifting device (A) by turning the clamping screw (B). Therefore, use the hexagon key that is located on the right of the clamping screw.
- Carefully pull the particle filter (see chapter 2.1) out of the housing.
- Push the new particle filter back into the particle filter housing as far as it will go.  
**NOTICE** Only use TEKA spare filters. Otherwise the proper functioning of the unit is not guaranteed, and there is a danger to life and limb.
- Elevate the lifting device by turning the clamping screw so that the particle filter is pressed tightly against the above housing.
- Close the service door.

## 7.4. Replacing the UV-C lamp

	<b>CAUTION</b>
<b>Risk of burns when touching the UV-C lamp.</b> After switching off the system, wait 5 minutes before changing.	

	<b>NOTICE</b>	
<b>Reduction of the UV-C light transmission is possible.</b> Grease residues can burn into the glass elements. Do not touch the glass elements with your fingers. Use gloves.		

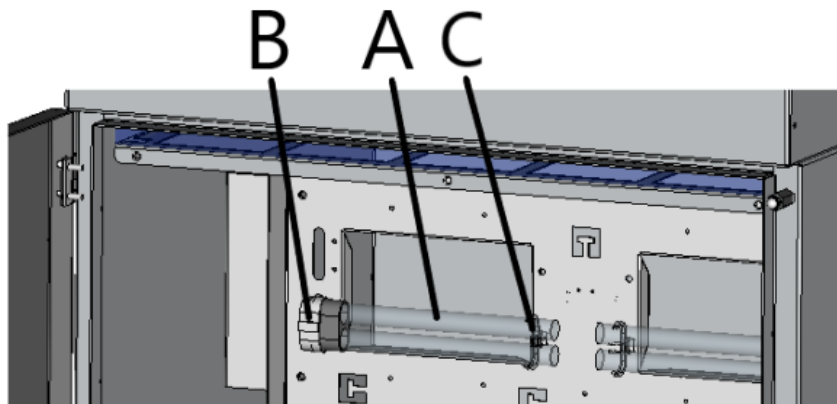



- Open the service door of the lamp housing (see chapter 2.1).
- Now carefully pull all the UV-C lamps (A) out from their sockets (B). To do this, the UV-C lamp must also be released from the holder (C).
- Insert the new UV-C lamps.  
**NOTICE** Only use TEKA spare parts. Otherwise the proper functioning of the unit is not guaranteed, and there is a danger to life and limb.
- Close the service door.

## 8. Dismantling / Disposal

Only authorised personnel may disassemble the machine.

	<b>WARNING</b>
<b>Dangers arising from electricity.</b> Before the dismantling of the machine it has to be disconnected from the power supply and all supply lines.	

	<b>CAUTION</b>
<b>Whirling up dust is possible due to the deposited dust.</b> During all work a suitable respiratory protection and protective clothing have to be worn.	

	The operator is obliged to store and dispose of the collected dust in accordance with national or regional regulations.
---	---

## 9. Diagnostics and troubleshooting

A list of possible system errors is provided in the table.



Faults indicated by control elements are explained in the chapter "Description of the control elements".

A recommissioning of the device must only occur if it is ensured that the system is functionally equivalent to the original state. Repairs may only be carried out by TEKA personnel or, after consultation with TEKA GmbH, by the personnel authorised by the operator.

Adhere to the instructions in the chapter "Safety instructions" and "Maintenance" when carrying out any repairs. If in doubt, contact our TEKA service department:

Tel: +49 2541-84841-0

E-mail: info@teka.eu

Fault	Cause	Removal
System does not start.	Plug power supply is missing or incorrectly inserted.	Plug connector check power supply / plug in correctly.
	No power at outlet.	Check the mains, remove error if possible.
Suction power too low	Filter element is saturated.	Replace the filter package, dispose of old filter properly!
	Suction line contracted.	Check and fix.
	Exhaust line contracted.	Check and fix.

## 10. List of spare parts



### WARNING

**Dangers to life and limb when non-original spare parts are used.**  
Only original TEKA spare parts must be used.

Filter element	Article no.
Particle filter "H14" (592 x 592 x 300)	20170260114
Prefilter mat "M5" (10 pieces / 610 x 610 x 20 mm)	10032
Other parts	Article no.
UV-C lamp	100310

## 11. Technical data

Supply voltage	V	230
Frequency	Hz	50
Type of current	Ph	1
Engine power	kW	0,55
Air flow volume max.	m³/h	3000
Protection class		IP54
ISO class		F
Width	mm	785
Depth	mm	800
Height	mm	3200
Weight	kg	235
Sound pressure level	dB(A)	65
Allowed ambient temperature	°C	+5 to +35 (during operations) -10 to +40 (during transport and storage)
Allowed max. humidity	%	70



## 12. EC declaration of conformity

*according to the Machinery Directive 2006/42/EG, Annex II, 1 A*

TEKA Absaug- und Entsorgungstechnologie GmbH

Millenkamp 9, D-48653 Coesfeld

Tel.: +49 2541-84841-0

E-Mail: [info@teka.eu](mailto:info@teka.eu)

Internet: [www.teka.eu](http://www.teka.eu)

Designation of the device: ViroLine Tower

We hereby declare under our sole responsibility that the product mentioned above, from the serial number A22600010011001 resp. P57300010011001 on, conforms to the following directives:

**Machinery Directive:** 2006/42/EG

**Electromagnetic Compatibility:** 2014/30/EU

**RoHS directive:** 2011/65/EU

This declaration will become void if the device is exposed to modifications that are not approved by the manufacturer in written form.

Authorized representative for the technical documentation:

TEKA Absaug- und Entsorgungstechnologie GmbH, Millenkamp 9, D-48653 Coesfeld

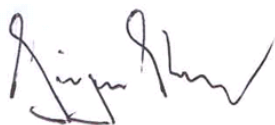

*(Jürgen Kemper, managing director)*

Coesfeld, 3rd January 2023



## 13. Training protocol

Designation of the device: ViroLine Tower

*(This form can be used by the operator to document the training of the employees. Training should be performed by authorized personnel only. Refer to the instructions in Chapter "Safety Instructions")*

By his signature, the employee confirms that he has been instructed regarding the following items:

Instruction	completed
Description of the device	
Operation and application of the device	
Explanation of the safety instructions	
Behavior in case of fire	
Explanation of the operation elements	
Change and dedusting of the filter elements	
Appropriate disposal	
Maintenance works / Maintenance intervals	

Name of the employee (legible)	Signature

Introduction through (legible):	
Signature:	

## 14. Maintenance intervals

### 14.1. Usage-related maintenance

The described maintenances become necessary through the demands of the system operations. The maintenance intervals are recommendations. Depending on the application (multi-shift operation, dust generation, ...) it may make sense for the operator to change the intervals of maintenance, replacing and cleaning.

Maintenance work must always be documented by means of a protocol.

The approach of the maintenance measures is described in chapter "Maintenance".

Maintenance work	Chapter	Maintenance interval	
		recommended by TEKA	determined by the operator
Replacing the particle filter	7.3	The saturation of the particle filter is automatically monitored by the filter unit and thus is not subject to a maintenance interval. The filter unit triggers an alarm when a replacement of the particle filter is necessary.	
Replacing the prefilter mat (or check the degree of pollution)	7.2	quarter-annually	
Replacing the UV-C lamps	7.4	after 9000 operation hours (this is absolutely necessary as the lamps lose intensity over time)	

### 14.2. General maintenance

The described maintenances are independent from the demands of the system operations.

The operator is obliged to carry out repeated inspections and functional tests according to national regulations. If not otherwise covered by national regulations, the described maintenance intervals must be respected.

Maintenance work must always be documented by means of a protocol.

Maintenance work	Chapter	Maintenance interval
<b>Visual</b> inspection of the device	14.2.1	weekly
<b>Functional</b> test of the device	14.2.2	monthly
<b>Electrical</b> test of the electrical lines and earthing connections	14.2.3	annually

## 14.2.1. Visual inspection of the device

**Visual inspection:** Observation that there are no visible safety-related defects.

	<b>WARNING</b> <b>Danger arising from the ready to operate condition of the device.</b> Follow the procedure as described in the chapter "Set to maintenance state".
---	--

The following steps must be carried out in the course of the visual inspection:

- Ensure that all parts are firmly connected.
- Check all metal parts for corrosion or damages / changes of the coating.
- Visual inspection of the control and operating elements as well as the outside running cables for damages.

## 14.2.2. Functional test of the device

	<b>NOTICE</b> <b>Possible material damage due to faulty condition of the unit.</b> Carry out a visual inspection before the functional test of the device as described in the previous chapters. The work as described in the chapter "Commissioning" must be finished.
--	--

The following steps must be carried out in the course of the functional test:

- Switch on the device.
- Pay attention to extraneous noises or vibrations during the device's operation.
- Check if the collection of the ambient air is sufficient. (Visual inspection).

## 14.2.3. Electrical test of the electrical lines and earthing connections

	<b>WARNING</b> <b>Danger arising from electricity.</b> The operator is responsible for ensuring that all work on electric components is carried out by authorised and qualified personnel.
---	--

The device is subject to regular electrical checks by the operator of the device, and are subject to national standards of the different countries.

The here recommended maintenance interval complies with the in Germany applying "Regulation 3 of the German Social Accident Insurance - Electrical plants and equipment" (formerly known as BGV-A3).

The check must only be carried out by a qualified electrician or a person trained in electrics using suitable measuring and test devices. The scope of testing and the methods must be in line with the respective national standard. All contacts in the control cabinet must be checked for tight fit, and must be readjusted if necessary.